

0 611 253 743

Issue } 14-02-07
Stand } **Fig./Abb. 2**

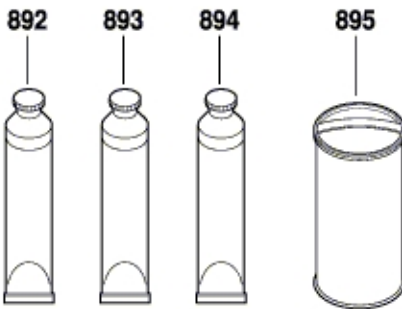
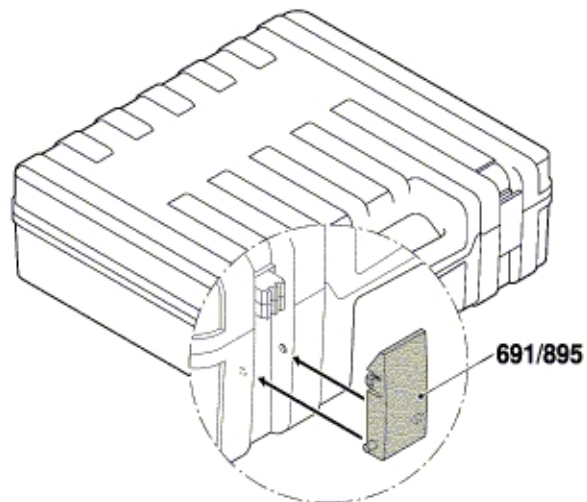
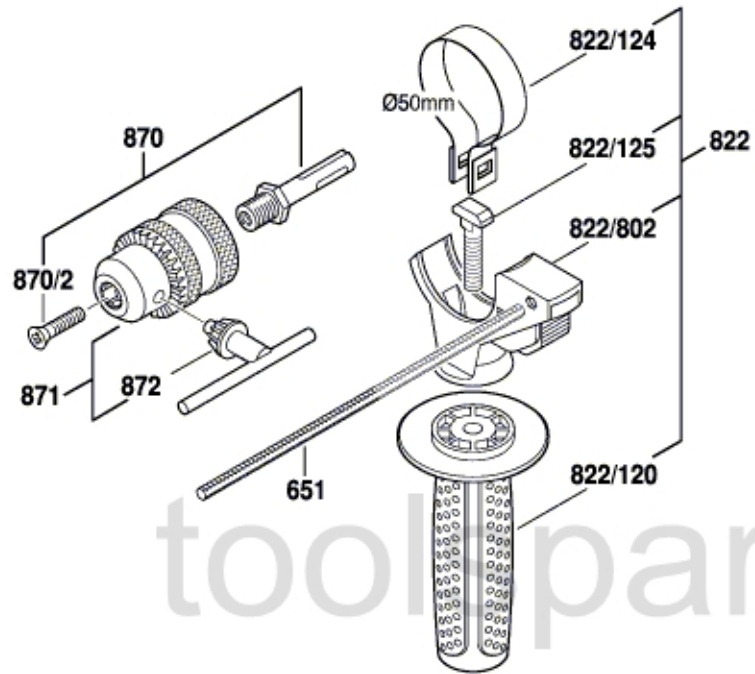

Modifications reserved
Änderungen vorbehalten
Modifications réservées
Salvo modificaciones